

Embedded System Design

Stephen A. Edwards

Columbia University

Spring 2023

Spot the Computer

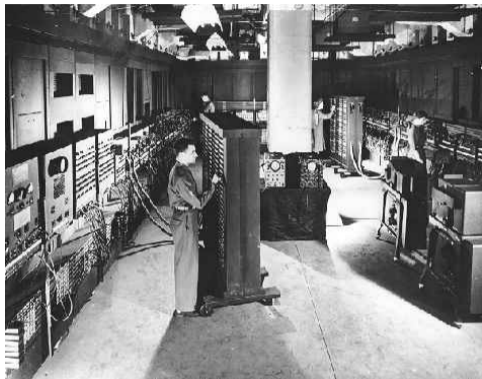

Cars These Days...

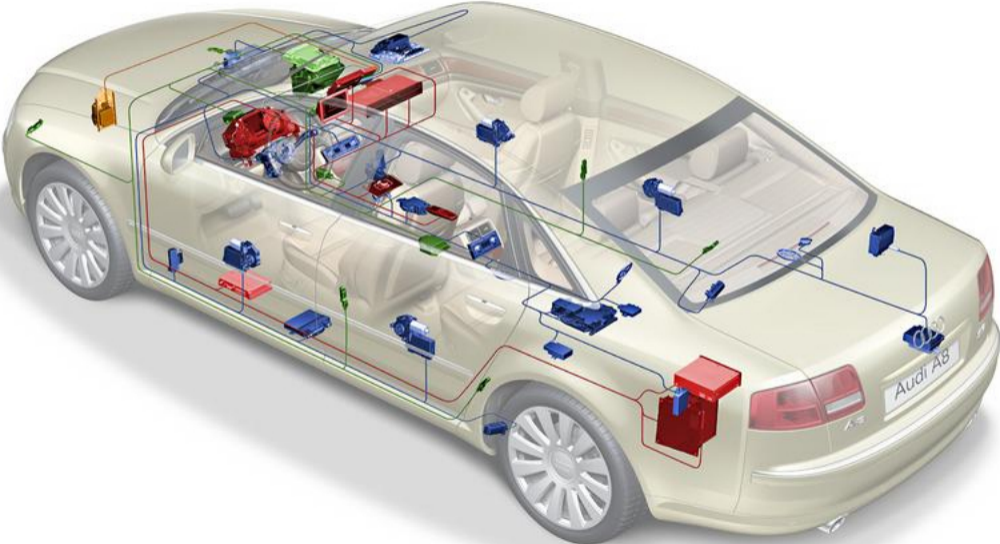

Embedded Systems: Ubiquitous Computers



iPhone



Laser Keyboard



Nikon D5600



WiFi Light Bulb



IP Phone



Playstation 5



PC Keyboard



Micro SD Card

Inside a Network Camera

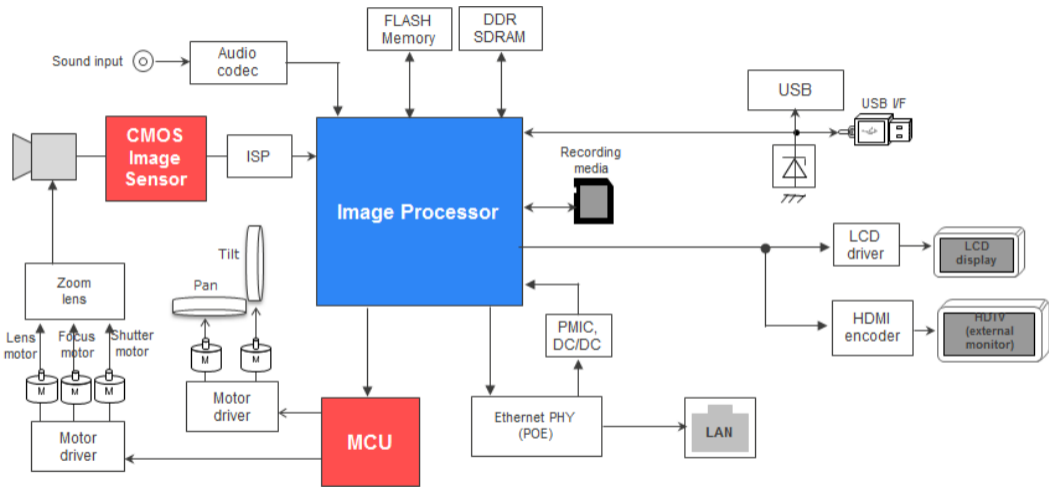

Source: Renesas

Want an Optimal Device that Meets Constraints On



Price



Functionality



Performance



Size



Power



Time-to-market



Maintainability



Safety

Embedded System Technologies

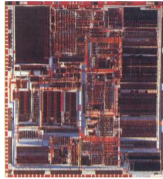

Integrated Circuits



Processing elements



Design tools

IC Technology

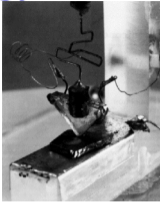

1947: First transistor (Shockley, Bell Labs)



1958: First integrated circuit (Kilby, TI)

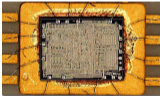

1971: First microprocessor (4004: Intel)

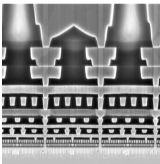

2018: Intel "10 nm" process, 12 layers

Moore's Law: Transistors per chip

"The complexity for minimum component costs has increased at a rate of roughly a factor of two per year. Certainly over the short term this rate can be expected to continue, if not to increase."

— Gordon Moore, 1965

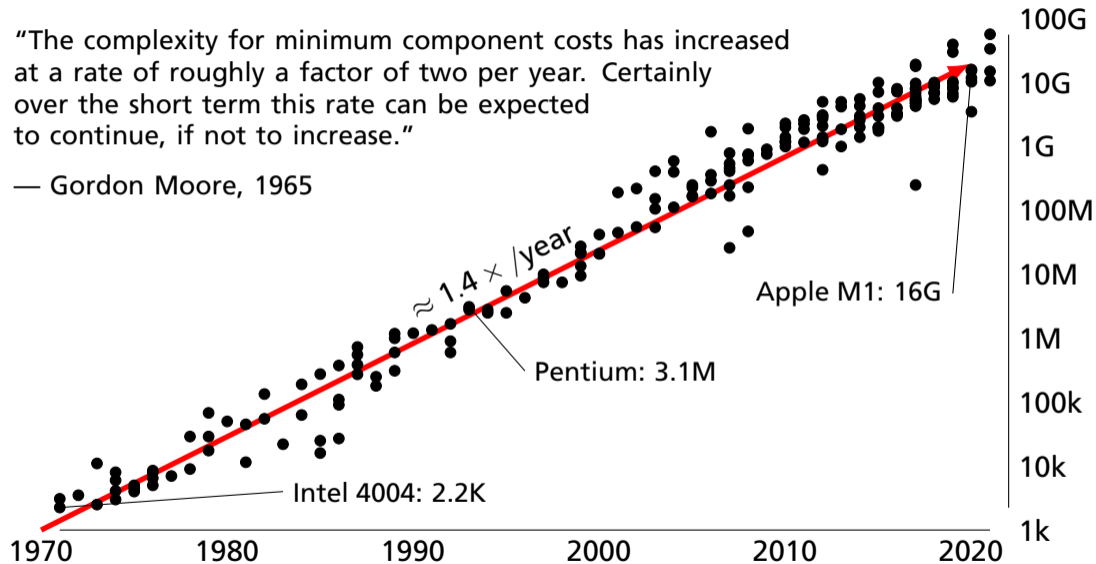

\$1000 Buys You This Many Cycles per Second

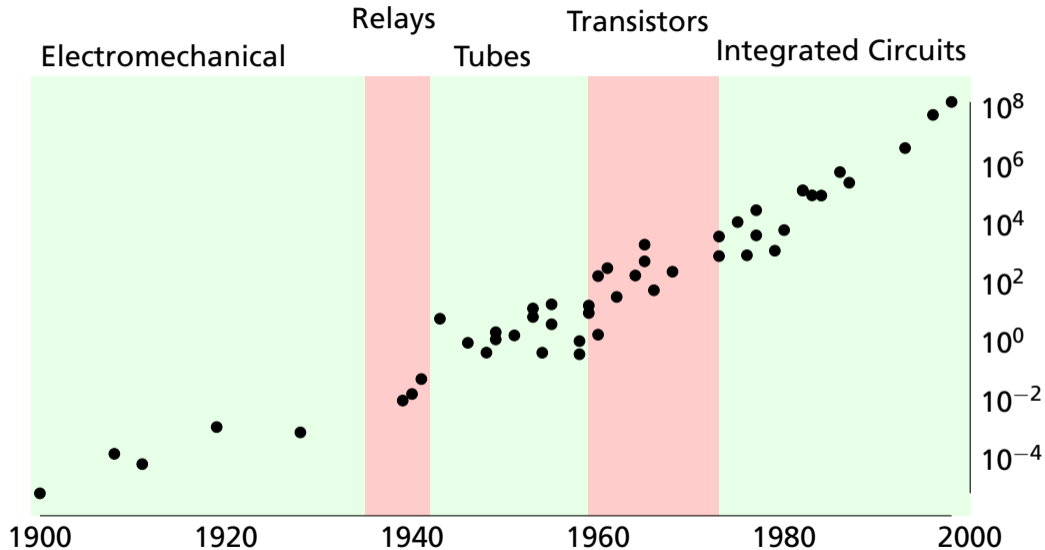

Source: Ray Kurzweil, *The Age of Spiritual Machines*

1918 Sears Roebuck Catalog

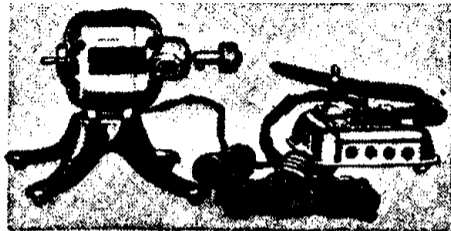

Home Motor.

This motor, as shown above, will operate a sewing machine. Easily attached; makes sewing a pleasure. The many attachments shown on this page may be operated by this motor and help to lighten the burden of the home. Operates on usual city current of 105 to 115 volts. Shipping weight, about 5 pounds.

No. 57P7564 Price, complete, as shown..... **\$8.75**

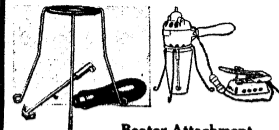
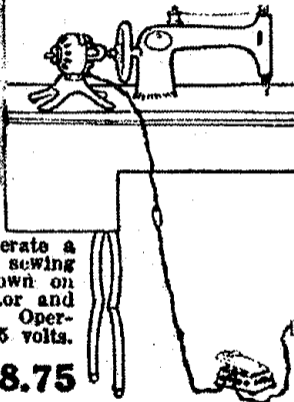

Beater Attachment.

Whips cream and beats eggs, and many other uses will be found for these attachments when used in connection with the Home Motor. Parts include the stand, handle and the beater. Shipping weight, about 14 ounces.

No. 57P7585 Price..... **\$1.30**



Churn and Mixer Attachment.

Used in connection with the Home Motor, makes a small churn and mixer for which you will find many uses. The attachments include the base, supports, mixer, handle and special cover for jar. Shipping weight, about 1 1/2 pounds.

No. 57P7582 Price..... **\$1.30**



Fan Attachment.

Includes fan and guard which can be quickly attached to Home Motor, and will be a great comfort in hot weather. Shipping weight, about 14 ounces.

No. 57P6215 Price..... **\$1.30**

About \$150 in 2022 dollars.

From Donald Norman, *The Invisible Computer*, 1998.

What Percentage of Time Do You Spend...

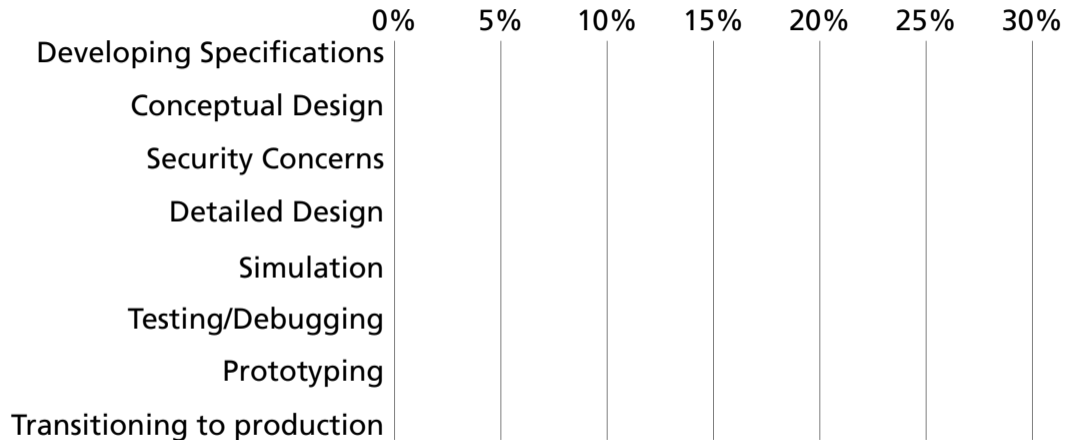

Source: 2019 Embedded Market Study

What Percentage of Time Do You Spend...

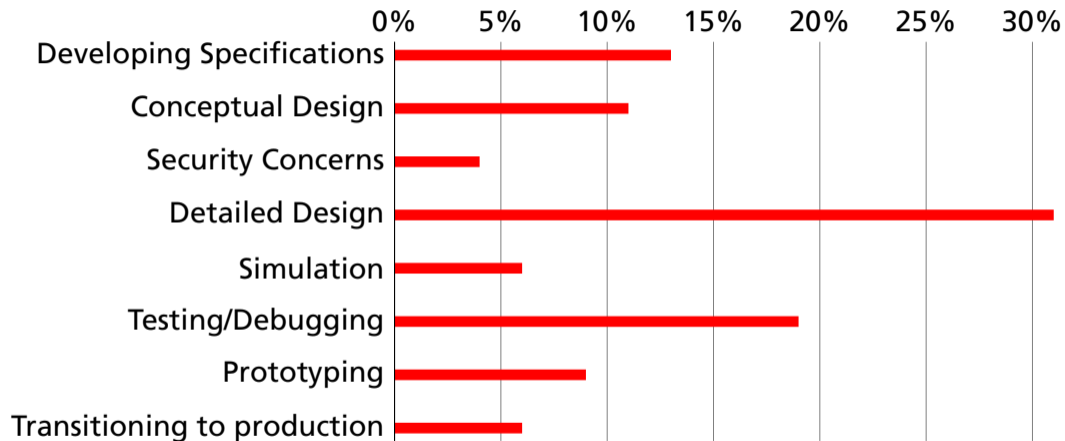

Source: 2019 Embedded Market Study

Does Your Current Project Contain FPGAs?

33% Yes

67% No

Source: 2019 Embedded Market Study

Why Won't Your Next Project Use FPGAs?

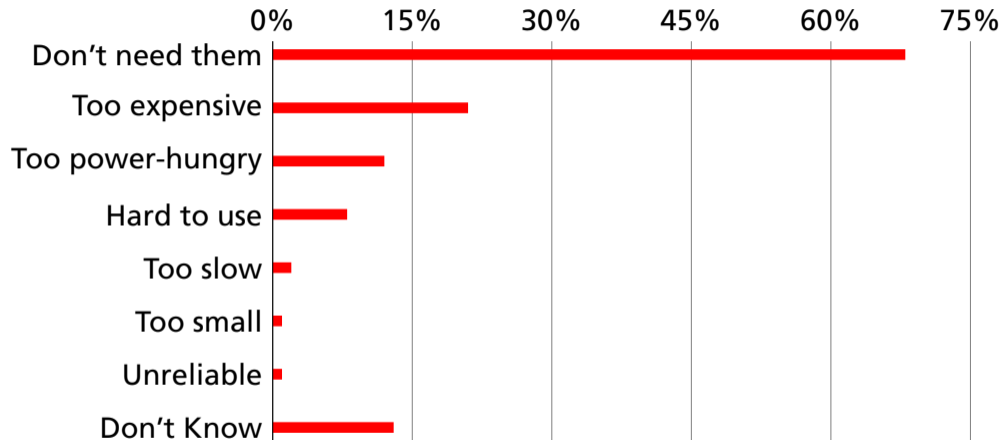

Source: 2009 Embedded Market Study

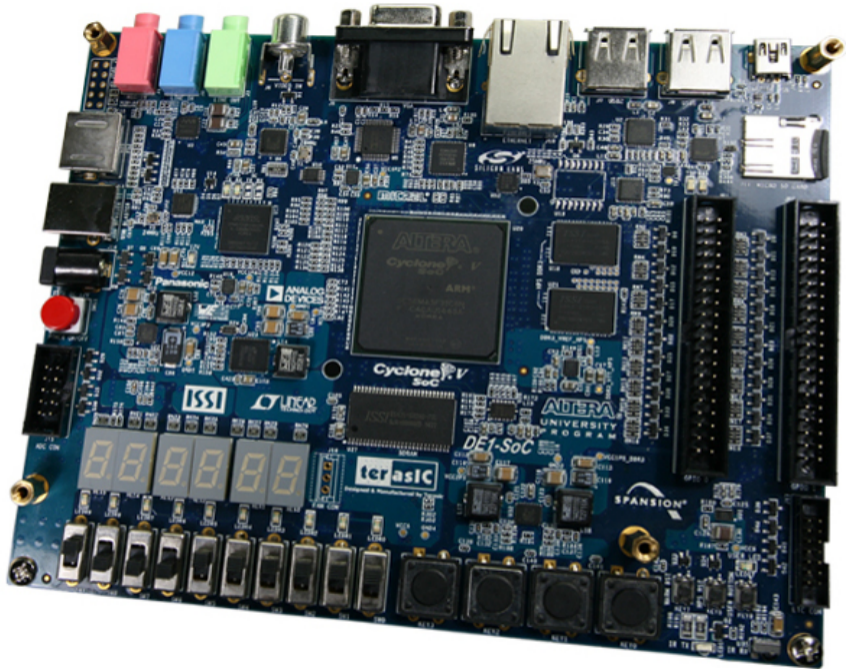

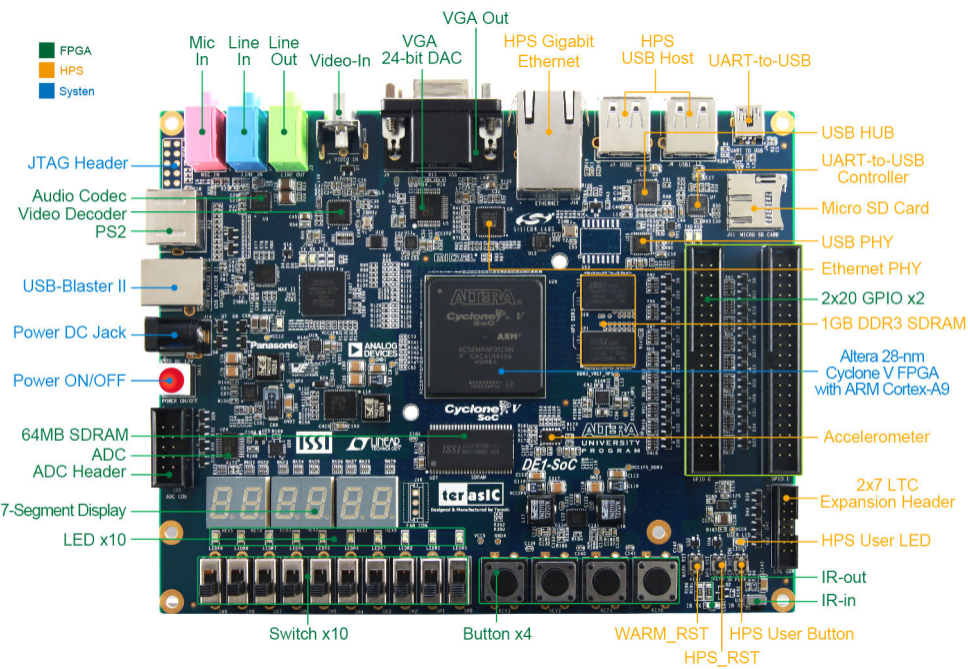

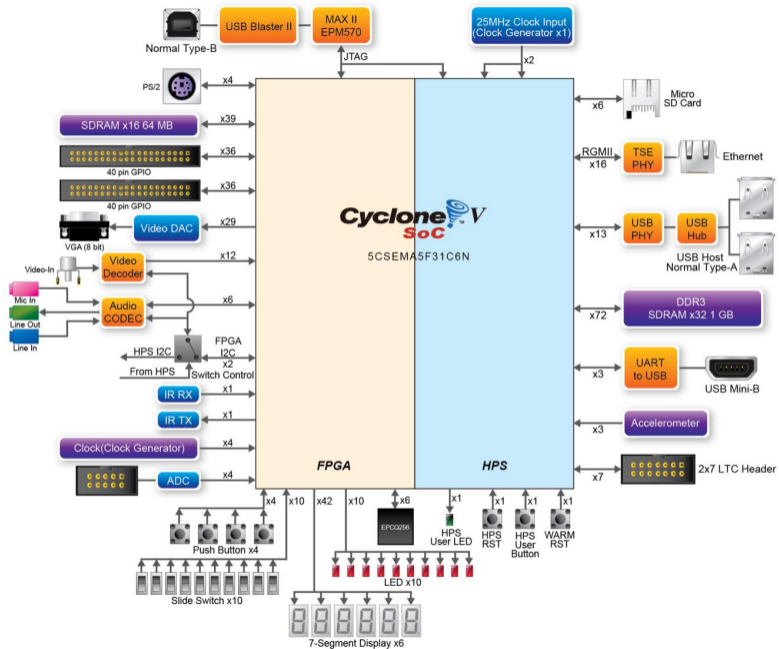

Inside the Cyclone V: Dual ARM processors + FPGA

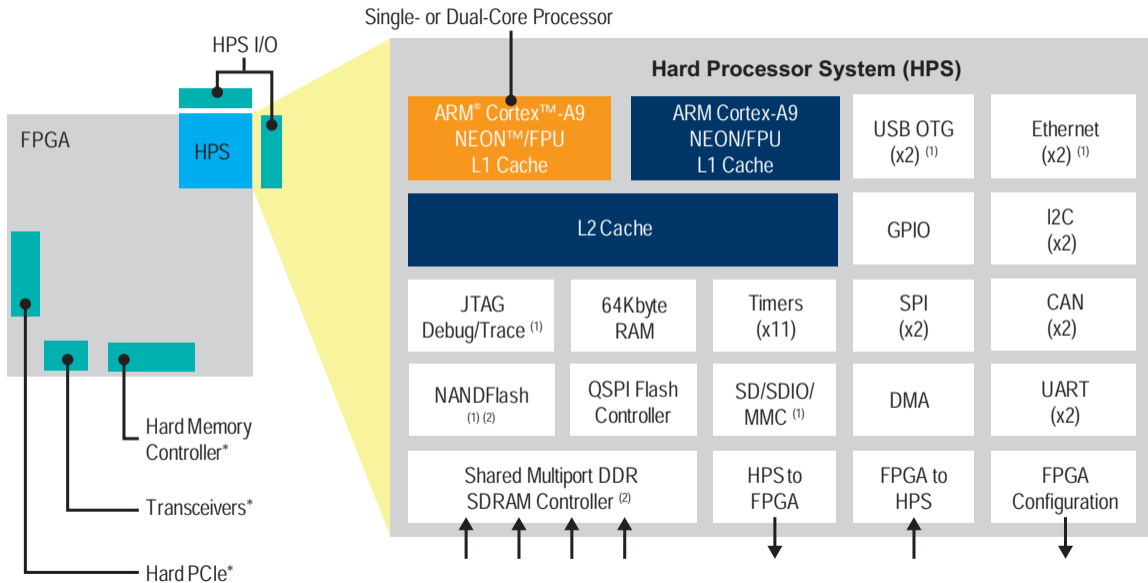

An Example System

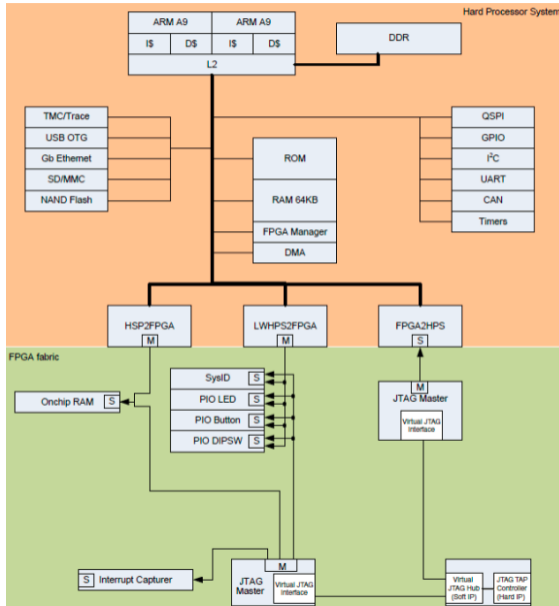

Linux + Custom Hardware

The screenshot shows a Mozilla Firefox browser window with the URL `parts.arrow.com/item/detail/arrow-development-tools/sockit`. The page title is "SOCKIT Development Kits and Tools by Arrow Development Tools". A "Set an Alert" button is visible. The main content area features the "SOCKIT DEVELOPMENT KIT" with a "SOCKIT Datasheet" link. Below this, the "PART DETAILS & PARAMETRIC" section includes a table:

EU RoHS	Supplier Unconfirmed
Technology	FPGA

The "DESCRIPTION" section contains the following text:

The SoCKit Development Kit presents a robust hardware design platform built around the Altera System-on-Chip (SoC) FPGA, which combines the latest dual-core Cortex-A9 embedded cores with industry-leading programmable logic for ultimate design flexibility. Users can now leverage the power of tremendous re-configurability paired with a high-performance, low-power processor system. Altera's SoC integrates an ARM-based hard processor system (HPS) consisting of processor, peripherals, and memory interfaces tied seamlessly with the FPGA fabric.

The browser's address bar shows the user is logged in as `root@localhost`.

+

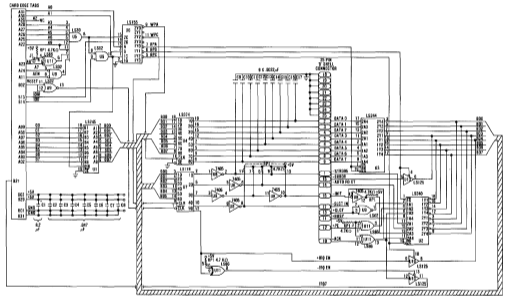

Class Structure

Three Introductory Labs: 2 weeks each

1. Hardware: Test the Collatz Conjecture
 2. Software: A simple Internet chat client
 3. HW + SW: A video bouncing ball
-

The project: **Design-your-own**

Work in groups if you can

Broadly: C + SystemVerilog + peripheral(s)

Broad Project Idea: Video Game

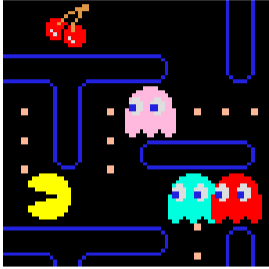

Implement graphics in custom hardware

Put game logic in software

Interface with USB HID (Joystick, etc.)

E.g., Pac-man, 2.5D maze game, tank, worms

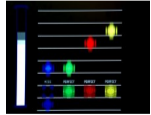
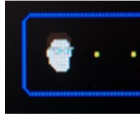
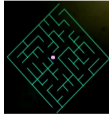
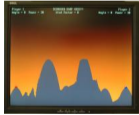

Broad Project Idea: Computational Accelerator

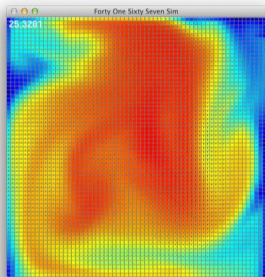

Pick a computationally intensive algorithm

Implement its core in custom hardware

Write software and device drivers that pass data to and from the accelerator

E.g., Smoke simulator, inverse kinematics for robotics, Bitcoin miner

More Ideas



Digital tone control

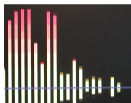

Spectrum analyzer



Internet radio



Speech Synthesizer



MIDI synthesizer



Accelerated JPEG

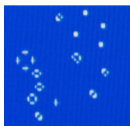

Game of Life

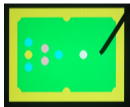

Pool game

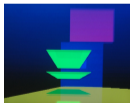

Real-time ray tracer

The Three Main Challenges of Embedded Systems



Coping with Real-World Sensor Data

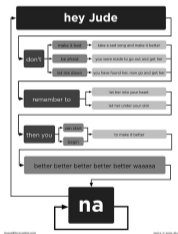

Algorithm Design

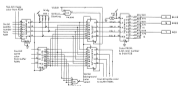

Implementation Details

What Happens When You Press the Switch?

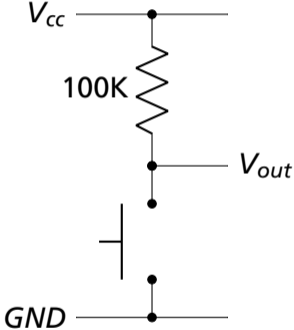

What Happens When You Press the Switch?

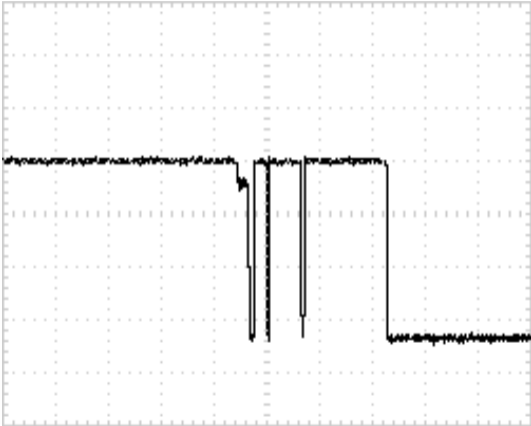
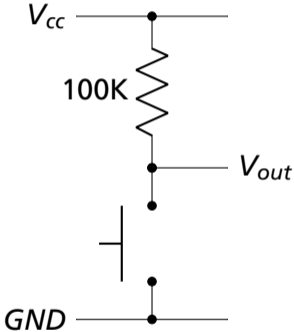

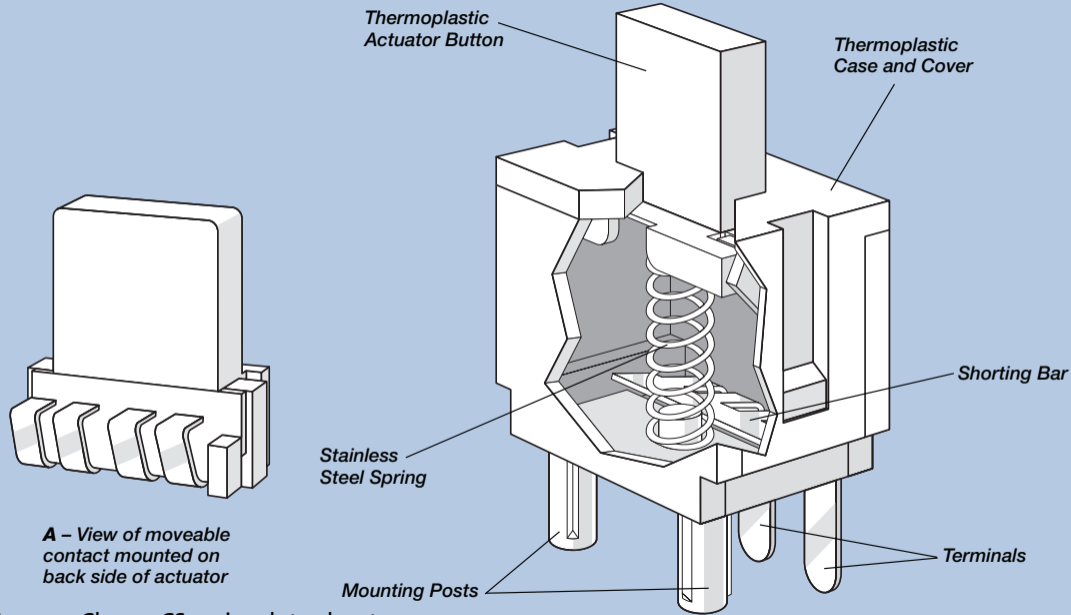

Source: Cherry CS series data sheet

Raw Data from a CCD (zoomed in)



Corrected Image (zoomed in)

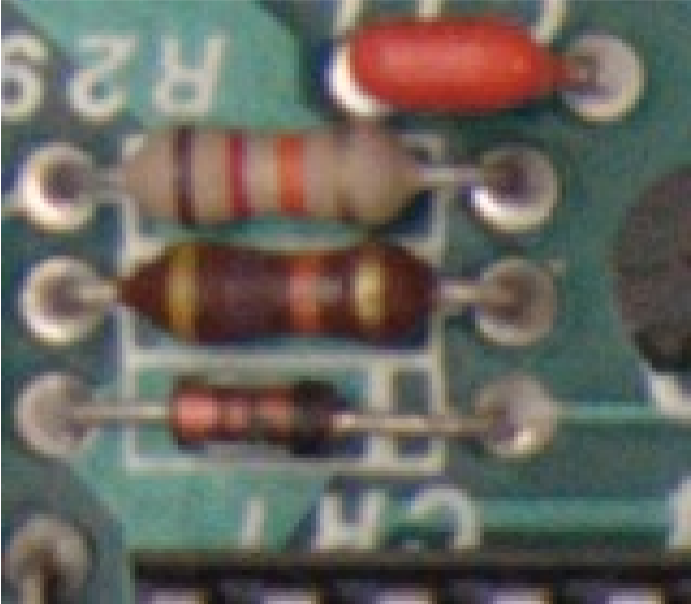

Correcting Data from CCDs

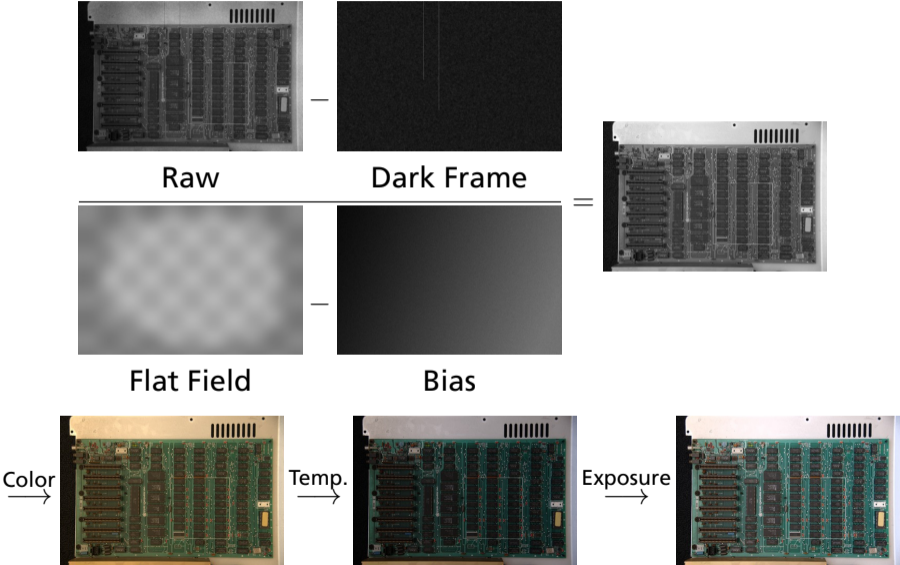

Correcting Data from CCDs

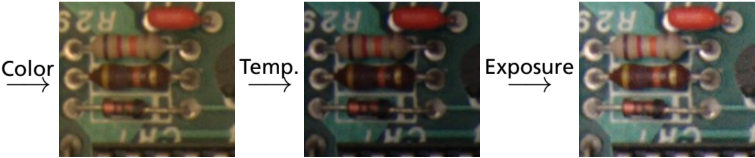
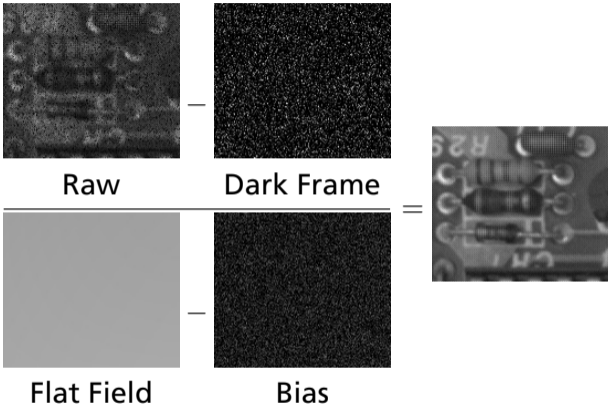

Where Does This Noise Come From?

Nikon D300: 23.6 mm \times 15.8 mm
12.3 megapixel CMOS sensor

Pixels are 5.5 μm on a side

A/D sampling of 12 bits per pixel measures

ISO:	LO	200	400	800	1600	3200
G	7.1	5.5	2.7	1.3	0.65	0.33
B	5.8	4.6	2.3	1.1	0.55	0.27
R	4.7	4.5	2.2	1.1	0.54	0.26

The units: *electrons per ADU* (digital unit).

Emil Martinec, *A comparison of the Nikon D300 and Canon 40D sensors*, 2007.

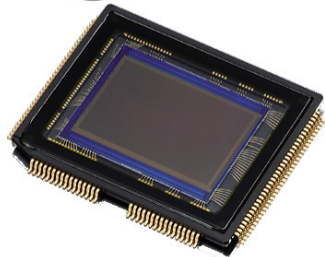

The Two Big Challenges

- ▶ Design the algorithm
 1. Acquire representative input (sensor) data
 2. Conceive of an algorithm
 3. Prototype the algorithm using your favorite language
- ▶ Implement the algorithm
 1. Choose a hardware/software partition based on performance and resource constraints
 2. Develop software and hardware architectures
 3. Define interface between software and hardware
 4. Implement the hardware and software
 5. Test, test, test...