

Lexical Analysis (Scanning)

Translates a stream of characters to a stream of tokens

f o o _ = _ a + _ bar (2, _ q) ;

ID	EQUALS	ID	PLUS	ID	LPAREN	NUM
COMMA	ID	LPAREN	SEMI			

Token	Lexemes	Pattern
EQUALS	=	an equals sign
PLUS	+	a plus sign
ID	a foo bar	letter followed by letters or digits
NUM	0 42	one or more digits

Lexical Analysis (Scanning)

Syntax and Parsing

COMS W4115
 Prof. Stephen A. Edwards
 Spring 2007
 Columbia University
 Department of Computer Science

Lexical Analysis

Goal: simplify the job of the parser.
 Scanners are usually much faster than parsers.
 Discard as many irrelevant details as possible (e.g., whitespace, comments).
 Parser does not care that the the identifier is "supercalifragilisticexpialidocious."
 Parser rules are only concerned with tokens.

Kleene Closure



The asterisk operator (*) is called the Kleene Closure operator after the inventor of regular expressions, Stephen Cole Kleene, who pronounced his last name "CLAY-nee."
 His son Ken writes "As far as I am aware this pronunciation is incorrect in all known languages. I believe that this novel pronunciation was invented by my father."

Describing Tokens

Alphabet: A finite set of symbols
 Examples: { 0, 1 }, { A, B, C, ..., Z }, ASCII, Unicode
String: A finite sequence of symbols from an alphabet
 Examples: ε (the empty string), Stephen, αβγ
Language: A set of strings over an alphabet
 Examples: ∅ (the empty language), { 1, 11, 111, 1111 }, all English words, strings that start with a letter followed by any sequence of letters and digits

Operations on Languages

Let $L = \{ \epsilon, wo \}$, $M = \{ man, men \}$
Concatenation: Strings from one followed by the other
 $LM = \{ man, men, woman, women \}$
Union: All strings from each language
 $L \cup M = \{ \epsilon, wo, man, men \}$
Kleene Closure: Zero or more concatenations
 $M^* = \{ \epsilon, M, MM, MMM, \dots \} = \{ \epsilon, man, men, manman, manmen, menmen, manmanman, manmannen, \dots \}$

Regular Expressions over an Alphabet Σ

- A standard way to express languages for tokens.
- ϵ is a regular expression that denotes $\{ \epsilon \}$
 - If $a \in \Sigma$, a is an RE that denotes $\{ a \}$
 - If r and s denote languages $L(r)$ and $L(s)$,
 - $(r)|(s)$ denotes $L(r) \cup L(s)$
 - $(r)(s)$ denotes $\{ tu : t \in L(r), u \in L(s) \}$
 - $(r)^*$ denotes $\bigcup_{i=0}^{\infty} L^i$ ($L^0 = \{ \epsilon \}$ and $L^i = LL^{i-1}$)

Regular Expression Examples

$\Sigma = \{ a, b \}$

RE	Language
$a b$	$\{ a, b \}$
$(a b)(a b)$	$\{ aa, ab, ba, bb \}$
a^*	$\{ \epsilon, a, aa, aaa, aaaa, \dots \}$
$(a b)^*$	$\{ \epsilon, a, b, aa, ab, ba, bb, aaaa, aaba, abba, \dots \}$
$a a^*b$	$\{ a, b, ab, aab, aaab, aacab, \dots \}$

Specifying Tokens with REs

Typical choice: $\Sigma = \text{ASCII characters, i.e., } \{_, !, ", \#, \$, \dots, 0, 1, \dots, 9, \dots, A, \dots, Z, \dots, \sim\}$
letters: $A|B|\dots|Z|a|\dots|z$
digits: $0|1|\dots|9$
identifier: **letter** (**letter** | **digit**)*

Implementing Scanners Automatically

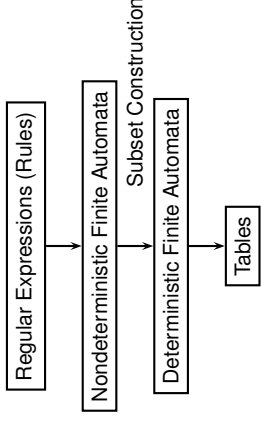

Nondeterministic Finite Automata

- "All strings containing an even number of 0's and 1's"
- Set of states $S: \{A, B, C, D\}$
 - Set of input symbols $\Sigma: \{0, 1\}$
 - Transition function $\sigma: S \times \Sigma_\epsilon \rightarrow 2^S$
 - Start state $s_0: A$
 - Set of accepting states $F: \{A\}$
- | state | ϵ | 0 | 1 |
|-------|------------|-----|-----|
| A | - | {B} | {C} |
| B | - | {A} | {D} |
| C | - | {D} | {A} |
| D | - | {C} | {B} |
-

The Language induced by an NFA

An NFA accepts an input string x iff there is a path from the start state to an accepting state that "spells out" x .

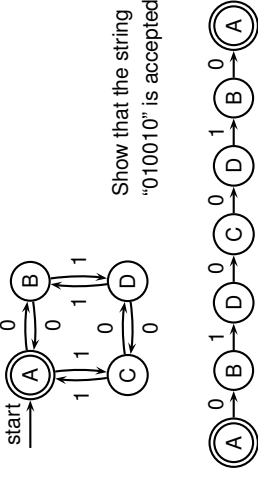

Translating REs into NFAs

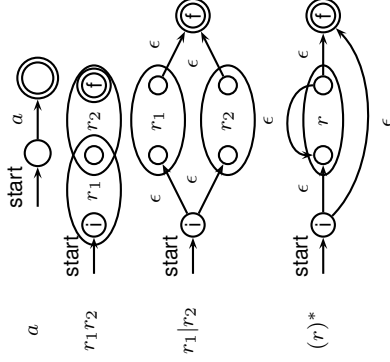

Translating REs into NFAs

Example: translate $(a|b)^*abb$ into an NFA

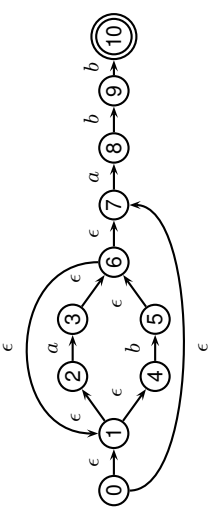

Show that the string "aabb" is accepted.

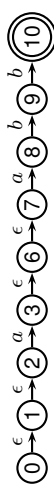

Simulating NFAs

Problem: you must follow the "right" arcs to show that a string is accepted. How do you know which arc is right?

Solution: follow them all and sort it out later.

"Two-stack" NFA simulation algorithm:

- Initial states: the ϵ -closure of the start state
- For each character c :
 - New states: follow all transitions labeled c
 - Form the ϵ -closure of the current states
- Accept if any final state is accepting

Simulating an NFA: -aabb, Start

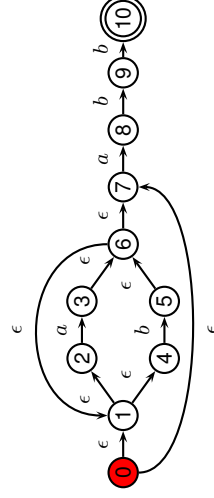

Simulating an NFA: -aabb, epsilon-closure

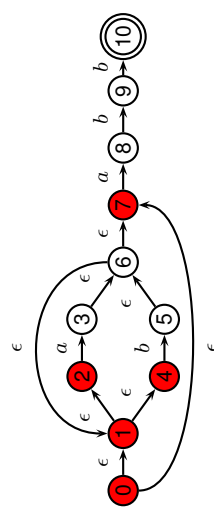

Simulating an NFA: $a \cdot abb$

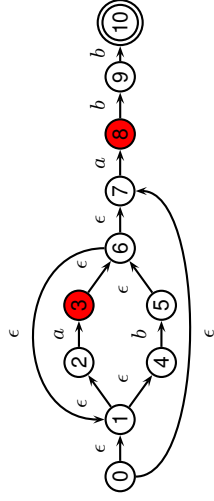

Simulating an NFA: $a \cdot abb, \epsilon$ -closure

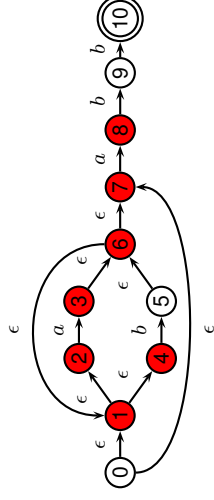

Simulating an NFA: $aa \cdot bb$

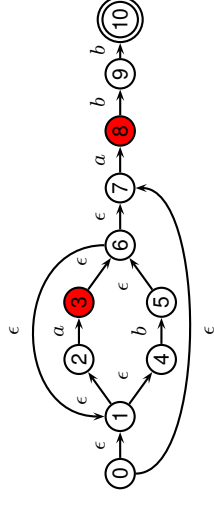

Simulating an NFA: $aa \cdot bb, \epsilon$ -closure

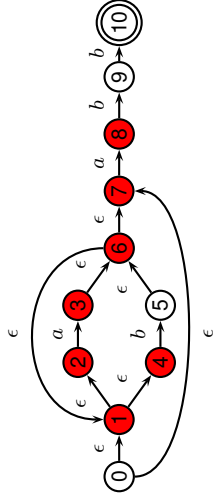

Simulating an NFA: $aab \cdot b$

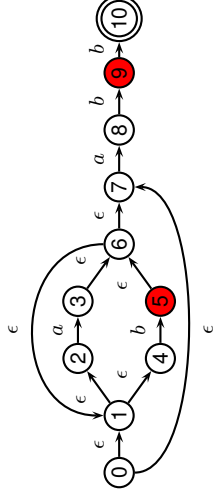

Simulating an NFA: $aab \cdot b, \epsilon$ -closure

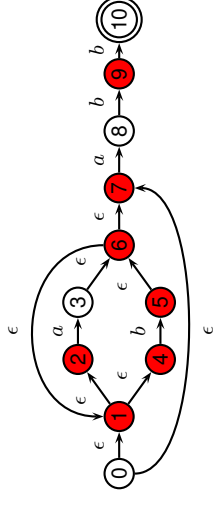

Simulating an NFA: $aabb \cdot$

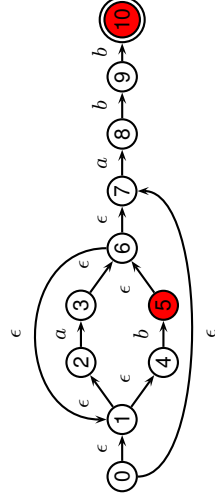

Simulating an NFA: $aabb \cdot, \text{Done}$

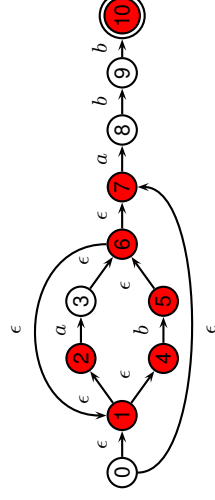

Restricted form of NFAs:

- No state has a transition on ϵ
- For each state s and symbol a , there is at most one edge labeled a leaving s .

Differs subtly from the definition used in COMS W3261 (Sipser, *Introduction to the Theory of Computation*)

Very easy to check acceptance: simulate by maintaining current state. Accept if you end up on an accepting state. Reject if you end on a non-accepting state or if there is no transition from the current state for the next symbol.

Deterministic Finite Automata

Deterministic Finite Automata

```
ELSE: "else" ;
ELSEIF: "elseif" ;
```

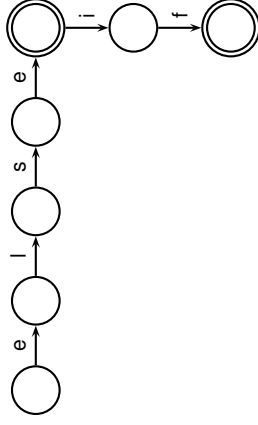

Deterministic Finite Automata

```
IF: "if" ;
ID: 'a'..'z' ('a'..'z' | '0'..'9')* ;
NUM: ('0'..'9')+ ;
```

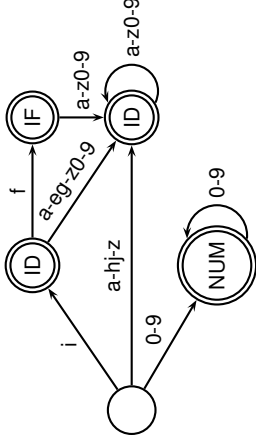

Building a DFA from an NFA

Subset construction algorithm

Simulate the NFA for all possible inputs and track the states that appear.

Each unique state during simulation becomes a state in the DFA.

Subset construction for $(a|b)^*abb$ (1)

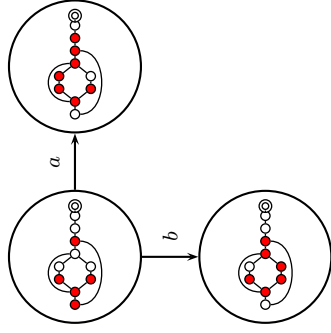

Subset construction for $(a|b)^*abb$ (2)

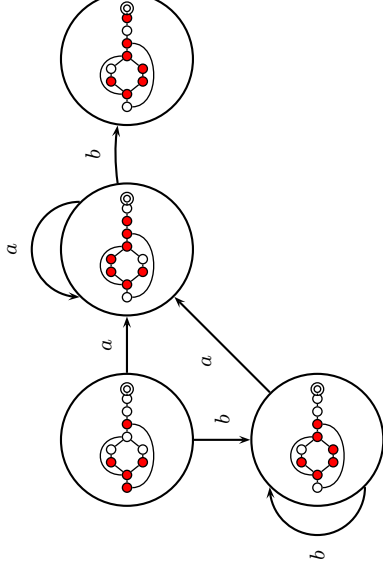

Subset construction for $(a|b)^*abb$ (3)

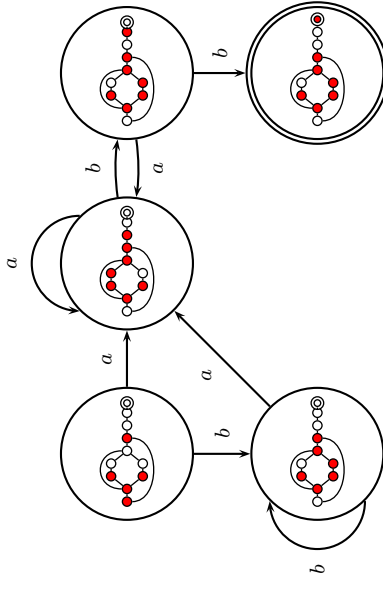

Subset construction for $(a|b)^*abb$ (4)

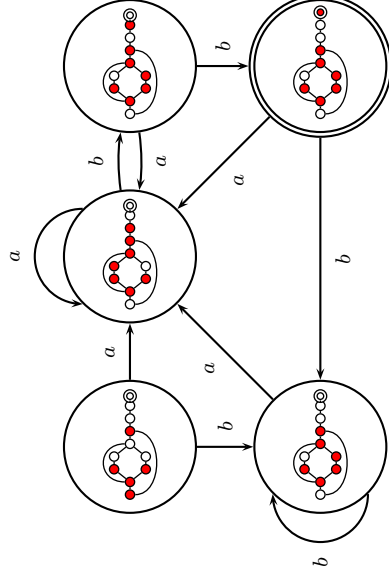

Subset Construction

An DFA can be exponentially larger than the corresponding NFA.

n states versus 2^n

Tools often try to strike a balance between the two representations.

ANTLR uses a different technique.

The ANTLR Compiler Generator

Language and compiler for writing compilers

Running ANTLR on an ANTLR file produces Java source files that can be compiled and run.

ANTLR can generate

- Scanners (lexical analyzers)
- Parsers
- Tree walkers

An ANTLR File for a Simple Scanner

```
class CalcLexer extends Lexer;
LPAREN : '(' ; // Rules for punctuation
RPAREN : ')' ;
STAR : '*' ;
PLUS : '+' ;
SEMI : ';' ;
protected
DIGIT : '0'..'9' ; // Can only be used as a sub-rule
INT : (DIGIT)+ ; // Any character between 0 and 9
// One or more digits
WS : (' ' | '\t' | '\n' | '\r') // Whitespace
{ $setType(Token.SKIP); } ; // Action: ignore
```

Free-Format Languages

Typical style arising from scanner/parser division

Program text is a series of tokens possibly separated by whitespace and comments, which are both ignored.

- keywords (`if while`)
- punctuation (`(+`)
- identifiers (`foo bar`)
- numbers (`10 -3.14159e+32`)
- strings (`"A String"`)

Python

The Python scripting language groups with indentation

```
i = 0
while i < 10:
    i = i + 1
    print i # Prints 1, 2, ..., 10

i = 0
while i < 10:
    i = i + 1
    print i # Just prints 10
```

This is succinct, but can be error-prone.

How do you wrap a conditional around instructions?

ANTLR Specifications for Scanners

Rules are names starting with a capital letter.

A character in single quotes matches that character.

```
LPAREN : '(' ;
```

A string in double quotes matches the string

```
IF : "if" ;
```

A vertical bar indicates a choice:

```
OP : '+' | '-' | '*' | '/' ;
```

ANTLR Specifications

Question mark makes a clause optional.

```
PERSON : ("wo")? 'm' ('a'|'e') 'n' ;
```

(Matches man, men, woman, and women.)

Double dots indicate a range of characters:

```
DIGIT : '0'..'9' ;
```

Asterisk and plus match "zero or more", "one or more."

```
ID : LETTER (LETTER | DIGIT)* ;
```

```
NUMBER : (DIGIT)+ ;
```

FORTRAN 77

FORTRAN 77 is not free-format. 72-character lines:

```
100 IF (IN.EQ. 'Y'.OR. IN.EQ. 'y').OR.
    $ IN.EQ. 'T'.OR. IN.EQ. 't') THEN
```



When column 6 is not a space, line is considered part of the previous.

Fixed-length line works well with a one-line buffer.

Makes sense on punch cards.

Syntax and Language Design

Does syntax matter? Yes and no

More important is a language's *semantics*—its meaning.

The syntax is aesthetic, but can be a religious issue.

But aesthetics matter to people, and can be critical.

Verbosity does matter: smaller is usually better.

Too small can be a problem: APL is a compact, cryptic language with its own character set (!)

```
E ← A TEST B;L
L ← 0.5
E ← (A×A) + B×B) *L
```

Syntax and Language Design

Some syntax is error-prone. Classic FORTRAN example:

```
DO 5 I = 1,25 ! Loop header (for i = 1 to 25)
DO 5 I = 1.25 ! Assignment to variable DO5I
```

Trying too hard to reuse existing syntax in C++:

```
vector< vector<int> > foo;
vector<vector<int>> foo; // Syntax error
```

C distinguishes `>` and `>>` as different operators.

Parsing

Objective: build an abstract syntax tree (AST) for the token sequence from the scanner.



Goal: discard irrelevant information to make it easier for the next stage.

Parentheses and most other forms of punctuation removed.

Parsing

Grammars

Most programming languages described using a *context-free grammar*.

Compared to regular languages, context-free languages add one important thing: recursion.

Recursion allows you to count, e.g., to match pairs of nested parentheses.

Which languages do humans speak? I'd say it's regular: I do not not not not not not not not not not understand this sentence.

Languages

Regular languages (t is a terminal):

$$A \rightarrow t_1 \dots t_n B$$

$$A \rightarrow t_1 \dots t_n$$

Context-free languages (P is terminal or a variable):

$$A \rightarrow P_1 \dots P_n$$

Context-sensitive languages:

$$\alpha_1 A \alpha_2 \rightarrow \alpha_1 B \alpha_2$$

" $B \rightarrow A$ only in the 'context' of $\alpha_1 \dots \alpha_2$ "

Operator Precedence and Associativity

Usually resolve ambiguity in arithmetic expressions

Like you were taught in elementary school:

"My Dear Aunt Sally"

Mnemonic for multiplication and division before addition and subtraction.

Issues

Ambiguous grammars

Precedence of operators

Left- versus right-recursive

Top-down vs. bottom-up parsers

Parse Tree vs. Abstract Syntax Tree

Operator Precedence

Defines how "sticky" an operator is.

$1 * 2 + 3 * 4$

* at higher precedence than +:
 $(1 * 2) + (3 * 4)$

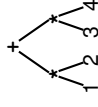

+ at higher precedence than *:
 $1 * (2 + 3) * 4$

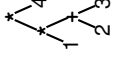

Associativity

Whether to evaluate left-to-right or right-to-left

Most operators are left-associative

$1 - 2 - 3 - 4$

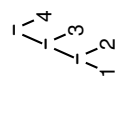

left associative

right associative

Ambiguous Grammars

A grammar can easily be ambiguous. Consider parsing

$3 - 4 * 2 + 5$

with the grammar

$e \rightarrow e + e \mid e - e \mid e * e \mid e / e \mid N$

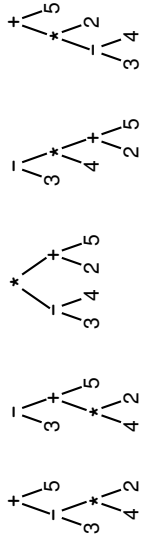

Fixing Ambiguous Grammars

Original ANTLR grammar specification

```
expr
: expr '+' expr
| expr '-' expr
| expr '*' expr
| expr '/' expr
| NUMBER
;
```

Ambiguous: no precedence or associativity.

Assigning Precedence Levels

Split into multiple rules, one per level

```
expr : expr '+' expr
      | expr '-' expr
      | term ;

term : term '*' term
      | term '/' term
      | atom ;

atom : NUMBER ;
```

Still ambiguous: associativity not defined

Assigning Associativity

Make one side or the other the next level of precedence

```
expr : expr '+' term
      | expr '-' term
      | term ;

term : term '*' atom
      | term '/' atom
      | atom ;

atom : NUMBER ;
```

Parsing Context-Free Grammars

There are $O(n^3)$ algorithms for parsing arbitrary CFGs, but most compilers demand $O(n)$ algorithms.

Fortunately, the LL and LR subclasses of CFGs have $O(n)$ parsing algorithms. People use these in practice.

Parsing LL(k) Grammars

LL: Left-to-right, Left-most derivation

k: number of tokens to look ahead

Parsed by top-down, predictive, recursive parsers

Basic idea: look at the next token to predict which production to use

ANTLR builds recursive LL(k) parsers

Almost a direct translation from the grammar.

Implementing a Top-Down Parser

```
stmt : 'if' expr 'then' expr
      | 'while' expr 'do' expr
      | expr ':' '=' expr ;

expr : NUMBER | '(' expr ')';

stmt() {
  switch (next-token) {
  case IF:
    match(IF); expr(); match(THEN); expr(); break;
  case WHILE:
    match(WHILE); expr(); match(DO); expr(); break;
  case NUMBER or LPAREN:
    expr(); match(COLEQ); expr(); break;
  }
}
```

Writing LL(k) Grammars

Cannot have left-recursion

```
expr : expr '+' term | term ;
becomes
AST expr() {
  switch (next-token) {
  case NUMBER : expr(); /* Infinite Recursion */

```

Writing LL(1) Grammars

Cannot have common prefixes

```
expr : ID '(' expr ')'
      | ID '=' expr
becomes
expr() {
  switch (next-token) {
  case ID:
    match(ID); match(LPAR); expr(); match(RPAR); break;
  case ID:
    match(ID); match(EQUALS); expr(); break;

```

Eliminating Common Prefixes

Consolidate common prefixes:

```
expr
: expr '+' term
| expr '-' term
| term
;
becomes
expr
: expr ('+' term | '-' term )
| term
;
```

Eliminating Left Recursion

Understand the recursion and add tail rules

```

expr
: expr '+' term | '-' term )
| term
;
becomes
expr : term exprt ;
exprt : '+' term exprt
      | '-' term exprt
      | /* nothing */
      ;

```

Using ANTLR's EBNF

ANTLR makes this easier since it supports * and -:

```

expr : expr '+' term
      | expr '-' term
      | term ;
becomes
expr : term ('+' term | '-' term)* ;

```

The Dangling Else Problem

Who owns the else?

```
if (a) if (b) c(); else d();
```

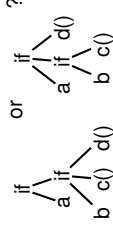

Grammars are usually ambiguous; manuals give disambiguating rules such as C's:

As usual the "else" is resolved by connecting an else with the last encountered elseless if.

The Dangling Else Problem

```
stmt : "if" expr "then" stmt iftail
      | other-statements ;
```

```
iftail
: "else" stmt
| /* nothing */
;
```

Problem comes when matching "iftail."

Normally, an empty choice is taken if the next token is in the "follow set" of the rule. But since "else" can follow an iftail, the decision is ambiguous.

The Dangling Else Problem

ANTLR can resolve this problem by making certain rules "greedy." If a conditional is marked as greedy, it will take that option even if the "nothing" option would also match:

```

stmt
: "if" expr "then" stmt
  ( options {greedy = true;}
  : "else" stmt
  )?
| other-statements
;

```

The Dangling Else Problem

Some languages resolve this problem by insisting on nesting everything.

E.g., Algol 68:

```
if a < b then a else b fi;
```

"fi" is "if" spelled backwards. The language also uses do-od and case-esac.

Statement separators/terminators

C uses ; as a statement terminator.

```

if (a<b) printf("a less");
else {
    printf("b"); printf(" less");
}

```

Pascal uses ; as a statement separator.

```

if a < b then writeln('a less')
else begin
    write('a'); writeln(' less')
end

```

Pascal later made a final ; optional.

Bottom-up Parsing

Rightmost Derivation

- 1: $e \rightarrow t + e$
- 2: $e \rightarrow t$
- 3: $t \rightarrow \text{Id} * t$
- 4: $t \rightarrow \text{Id}$

A rightmost derivation for $\text{Id} * \text{Id} + \text{Id}$:

```

[ ]
t + [ ]
t + [ ]
[ ] + Id
Id * [ ] + Id
Id * Id + Id

```

Basic idea of bottom-up parsing: construct this rightmost derivation **backward**.

Here, I've drawn a box around each symbol to expand.

Handles

- 1: $e \rightarrow t + e$
- 2: $e \rightarrow t$
- 3: $t \rightarrow \text{ld} * t$
- 4: $t \rightarrow \text{ld}$

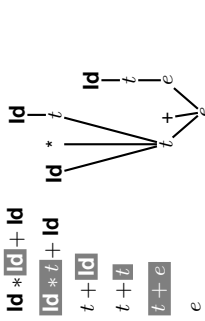

This is a reverse rightmost derivation for $\text{ld} * \text{ld} + \text{ld}$. Each highlighted region is a **handle**.

A handle is the right side of a rule that turns into a left.

In order, the handles build the tree leaves-to-root.

Shift-reduce Parsing

- 1: $e \rightarrow t + e$
 - 2: $e \rightarrow t$
 - 3: $t \rightarrow \text{ld} * t$
 - 4: $t \rightarrow \text{ld}$
- Stack: $\text{ld} * \text{ld} + \text{ld}$
 Input: $\text{ld} * \text{ld} + \text{ld}$
 Action: shift
 Stack: $\text{ld} * \text{ld} + \text{ld}$
 Input: $\text{ld} * \text{ld} + \text{ld}$
 Action: shift
 Stack: $\text{ld} * \text{ld} + \text{ld}$
 Input: $\text{ld} * \text{ld} + \text{ld}$
 Action: reduce (4)
 Stack: $\text{ld} * \text{ld}$
 Input: $\text{ld} * \text{ld} + \text{ld}$
 Action: reduce (3)
 Stack: t
 Input: $\text{ld} * \text{ld} + \text{ld}$
 Action: shift
 Stack: $t + \text{ld}$
 Input: $\text{ld} * \text{ld} + \text{ld}$
 Action: reduce (4)
 Stack: $t + t$
 Input: $\text{ld} * \text{ld} + \text{ld}$
 Action: reduce (2)
 Stack: $t + t$
 Input: $\text{ld} * \text{ld} + \text{ld}$
 Action: reduce (1)
 Stack: $t + e$
 Input: $\text{ld} * \text{ld} + \text{ld}$
 Action: accept

Scan input left-to-right, looking for handles.

An oracle tells what to do

LR Parsing

- 1: $e \rightarrow t + e$
- 2: $e \rightarrow t$
- 3: $t \rightarrow \text{ld} * t$
- 4: $t \rightarrow \text{ld}$

1. Look at state on top of stack
2. and the next input token
3. to find the next action
4. In this case, shift the token onto the stack and go to state 1.

goto	action	e	t
0	s1	7	2
1	r4 r4 s3 r4		
2	r2 s4 r2 r2		
3	s1		5
4	s1		6 2
5	r3 r3 r3 r3		
6	r1 r1 r1 r1		
7	acc		

LR Parsing

- 1: $e \rightarrow t + e$
- 2: $e \rightarrow t$
- 3: $t \rightarrow \text{ld} * t$
- 4: $t \rightarrow \text{ld}$

goto	action	e	t
0	s1	7	2
1	r4 r4 s3 r4		
2	r2 s4 r2 r2		
3	s1		5
4	s1		6 2
5	r3 r3 r3 r3		
6	r1 r1 r1 r1		
7	acc		

Action is reduce with rule 4

($t \rightarrow \text{ld}$). The right side is removed from the stack to reveal state 3. The goto table in state 3 tells us to go to state 5 when we reduce a t :

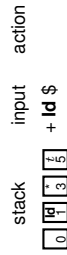

LR Parsing

- 1: $e \rightarrow t + e$
- 2: $e \rightarrow t$
- 3: $t \rightarrow \text{ld} * t$
- 4: $t \rightarrow \text{ld}$

goto	action	e	t
0	s1	7	2
1	r4 r4 s3 r4		
2	r2 s4 r2 r2		
3	s1		5
4	s1		6 2
5	r3 r3 r3 r3		
6	r1 r1 r1 r1		
7	acc		



The states are places we could be in a reverse-rightmost derivation. Let's represent such a place with a dot.

- 1: $e \rightarrow t + e$
- 2: $e \rightarrow t$
- 3: $t \rightarrow \text{ld} * t$
- 4: $t \rightarrow \text{ld}$

Say we were at the beginning ($\cdot e$). This corresponds to

- $e' \rightarrow \cdot e$
- $e \rightarrow \cdot t + e$
- $e \rightarrow t \cdot$
- $t \rightarrow \cdot \text{ld} * t$
- $t \rightarrow \text{ld} \cdot$

The first is a placeholder. The second are the two possibilities when we're just before e . The last two are the two possibilities when we're just before t .

Constructing the SLR Parsing Table

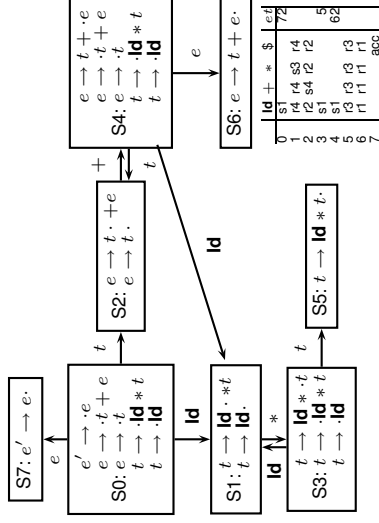

The Punchline

This is a tricky, but mechanical procedure. The parser generators YACC, Bison, Cup, and others (but not ANTLR) use a modified version of this technique to generate fast bottom-up parsers.

You need to understand it to comprehend error messages:

Shift/reduce conflicts are caused by a state like

- $t \rightarrow \text{ld} \cdot * t$
- $t \rightarrow \text{ld} * t \cdot$

Reduce/reduce conflicts are caused by a state like

- $t \rightarrow \text{ld} * t \cdot$
- $e \rightarrow t + e \cdot$