

Interpreter

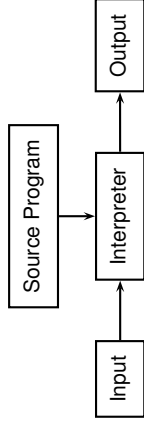

Compiler

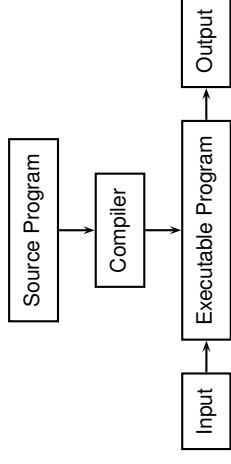

Language Processors

COMS W4115
 Prof. Stephen A. Edwards
 Fall 2005
 Columbia University
 Department of Computer Science

Bytecode Interpreter

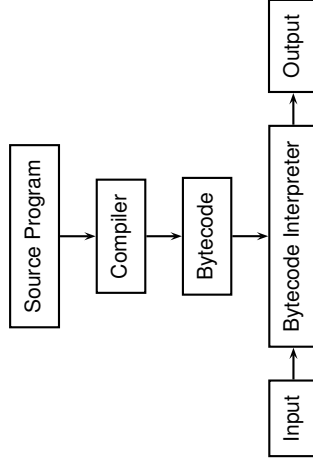

Just-in-time Compiler

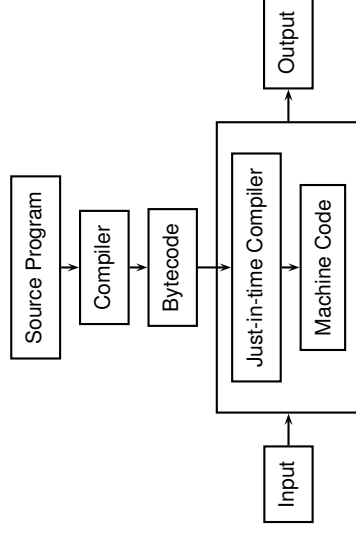

Language Speeds Compared

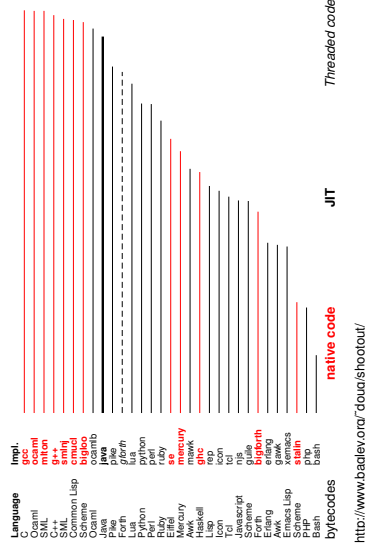

Separate Compilation

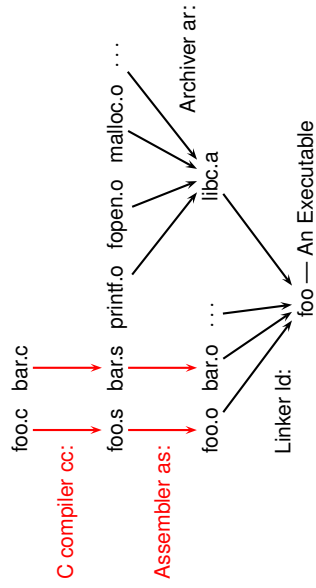

Preprocessor

"Messages" the input before the compiler sees it.

- Macro expansion
- File inclusion
- Conditional compilation

The C Preprocessor

```

cc -E example.c gives
#include <stdio.h>
extern int
#define min(x, y) \
    ((x) < (y)) ? (x) : (y)
... many more declarations
from stdio.h
int baz();
void foo();
void foo()
{
    int a = 1;
    int b = 2;
    int c;
    c = min(a,b);
}
  
```

Compiling a Simple Program

```
int gcd(int a, int b)
{
    while (a != b) {
        if (a > b) a -= b;
        else b -= a;
    }
    return a;
}
```

What the Compiler Sees

```
int gcd(int a, int b)
{
    while (a != b) {
        if (a > b) a -= b;
        else b -= a;
    }
    return a;
}
```

i n t s p g c d (i n t s p a , s p i
n t s p b) n l { n l s p s p w h i l e s p
(a s p ! = s p b) s p { n l s p s p s p i
f s p (a s p > s p b) s p a s p - = s p b
; n l s p s p s p e l s e s p b s p - = s p
a ; n l s p s p } n l s p s p r e t u r n s p
a ; n l } n l

Text file is a sequence of characters

Lexical Analysis Gives Tokens

```
int gcd(int a, int b)
{
    while (a != b) {
        if (a > b) a -= b;
        else b -= a;
    }
    return a;
}
```

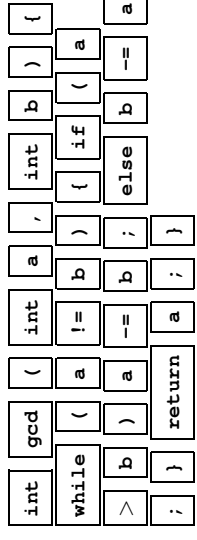

A stream of tokens. Whitespace, comments removed.



Parsing Gives an AST

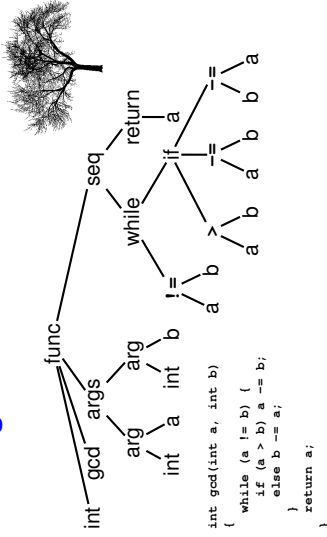

Semantic Analysis Resolves Symbols

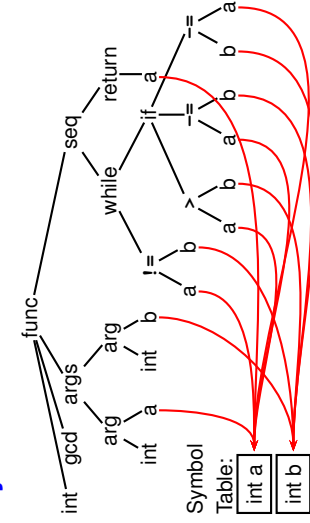

Types checked; references to symbols resolved

Translation into 3-Address Code

```
I0: sne $1, a, b
    seq $0, $1, 0
    btrue $0, I1 % while (a != b)
    s1 $3, b, a
    seq $2, $3, 0
    btrue $2, I4 % if (a < b)
    sub a, a, b % a -= b
    jmp I5
I4: sub b, b, a % b -= a
I5: jmp I0
I1: ret a

int gcd(int a, int b)
{
    while (a != b) {
        if (a > b) a -= b;
        else b -= a;
    }
    return a;
}
```

Idealized assembly language w/ infinite registers

Generation of 80386 Assembly

```
gcd: pushl %ebp
     movl %esp, %ebp
     movl 8(%ebp), %eax % Save FP
     movl 12(%ebp), %edx % Load a from stack
     .L8: cmpl %edx, %eax % Load b from stack
           je .L3 % while (a != b)
           jle .L5 % if (a < b)
           subl %edx, %eax % a -= b
           jmp .L8 % b -= a
     .L5: subl %eax, %edx % Restore SP, BP
           jmp .L8
     .L3: leave
           ret
```

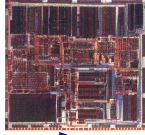

Abstract syntax tree built from parsing rules.