

Abstract Syntax Trees

COMS W4115



Prof. Stephen A. Edwards
Fall 2005
Columbia University
Department of Computer Science

Actions

In a top-down parser, actions are executed during the matching routines.

Actions can appear anywhere within a rule: before, during, or after a match.

```
rule { /* before */  
: A { /* during */ } B  
| C D { /* after */ } ;
```

Bottom-up parsers restricted to running actions only after a rule has matched.

Parsing and Syntax Trees

Parsing decides if the program is part of the language.

Not that useful: we want more than a yes/no answer.

Like most, ANTLR parsers can include *actions*: pieces of code that run when a rule is matched.

Top-down parsers: actions executed during parsing rules.

Bottom-up parsers: actions executed when rule is "reduced."

Implementing Actions

Nice thing about top-down parsing: grammar is essentially imperative.

Action code simply interleaved with rule-matching.

Easy to understand what happens when.

Actions

Simple languages can be interpreted with parser actions.

```
class CalcParser extends Parser;
```

```
expr returns [int r] { int a; r=0; }  
: r=mexpr ("+" a=mexpr { r += a; } ) * EOF ;
```

```
mexpr returns [int r] { int a; r=0; }  
: r=atom ("*" a=atom { r *= a; } ) * ;
```

```
atom returns [int r] { r=0; }
```

```
: i:INT
```

```
{ r = Integer.parseInt(i.getText()); } ;
```

Implementing Actions

```
expr returns [int r] { int a; r=0; }
```

```
: r=mexpr ("+" a=mexpr { r += a; } ) * EOF ;
```

```
public final int expr() { // What ANTLR builds
```

```
int r; int a; r=0;
```

```
r=mexpr();
```

```
while ((LA(1)!=PLUS)) { // ( ) *
```

```
match(PLUS); // "+"
```

```
a=mexpr(); // a=mexpr
```

```
r += a; // { r += a; }
```

```
}
```

```
match(Token.EOF_TYPE);
```

```
return r;
```

```
}
```

Actions

Usually, actions build a data structure that represents the program.

Separates parsing from translation.

Makes modification easier by minimizing interactions.

Allows parts of the program to be analyzed in different orders.

What To Build?

Typically, an Abstract Syntax Tree that represents the program.

Represents the syntax of the program almost exactly, but easier for later passes to deal with.

Punctuation, whitespace, other irrelevant details omitted.

Abstract vs. Concrete Trees

Like scanning and parsing, objective is to discard irrelevant details.

E.g., comma-separated lists are nice syntactically, but later stages probably just want lists.

AST structure almost a direct translation of the grammar.



Abstract vs. Concrete Trees

```

expr : mexpr ("+" mexpr ) * ;
mexpr : atom ("*" atom ) * ;
atom : INT ;
3 + 5 * 4
    
```

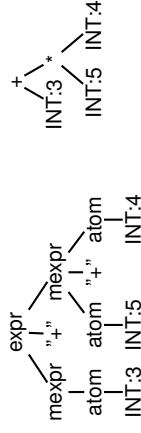

Concrete Parse Tree

Abstract Syntax Tree

Implementing ASTs

Most general implementation: ASTs are n -ary trees.

Each node holds a token and pointers to its first child and next sibling:

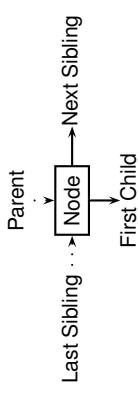

Implementing ASTs

Most general implementation: ASTs are n -ary trees.

Each node holds a token and pointers to its first child and next sibling:

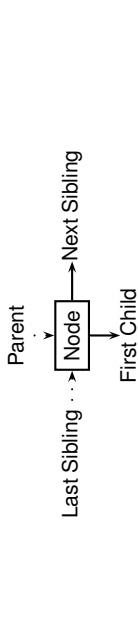

Example of AST structure

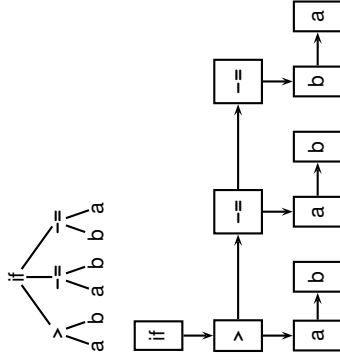

Typical AST Operations

Create a new node; Append a subtree as a child.

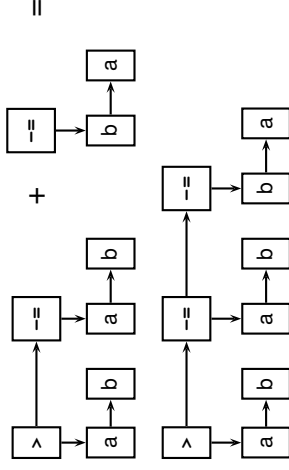

Comment on Generic ASTs

Is this general-purpose structure too general?

Not very object-oriented: whole program represented with one type.

Alternative: Heterogeneous ASTs: one class per object.

```

class BinOp {
    int operator; Expr left, right;
};
class IfThen {
    Expr predicate; Stmt thenPart, elsePart;
};
    
```

Heterogeneous ASTs

Advantage: avoid switch statements when walking tree.

Disadvantage: each analysis requires another method.

```

class BinOp {
    int operator; Expr left, right;
    void typeCheck() { ... };
    void constantProp() { ... };
    void buildThreeAddr() { ... };
};
    
```

Analyses spread out across class files.

Classes become littered with analysis code, additional annotations.

Comment on Generic ASTs

ANTLR offers a compromise:

It can automatically generate tree-walking code.

→ It generates the big switch statement.

Each analysis can have its own file.

Still have to modify each analysis if the AST changes.

→ Choose the AST structure carefully.

Building ASTs



The Obvious Way to Build ASTs

```

class ASTNode {
    ASTNode( Token t ) { ... }
    void appendChild( ASTNode c ) { ... }
    void appendSibling( ASTNode C ) { ... }
}

stmt returns [ASTNode n]
: 'if' p=expr 'then' t=stmt 'else' e=stmt
  { n = new ASTNode(new Token("IF"));
    n.appendChild(p);
    n.appendChild(t);
    n.appendChild(e); } ;

```

Automatic AST Construction

Running

```

class CalcParser extends Parser;
options { buildAST=true; }
expr : mexpr ('+' mexpr)* EOF ;
mexpr : atom ('*' atom)* ;
atom : INT ;

```

on

2*3+4*5+6

gives

Designing an AST Structure

Sequences of things

Removing unnecessary punctuation

Additional grouping

How many token types?

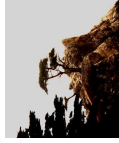

The Obvious Way

Putting code in actions that builds ASTs is traditional and works just fine.

But it's tedious.

Fortunately, ANTLR can automate this process.

Building an AST Automatically with ANTLR

```

class TigerParser extends Parser;
options {
    buildAST=true;
}

```

By default, each matched token becomes an AST node.

Each matched token or rule is made a sibling of the AST for the rule.

After a token, ^ makes the node a root of a subtree.

After a token, ! prevents an AST node from being built.

AST Construction with Annotations

Running

```

class CalcParser extends Parser;
options { buildAST=true; }
expr : mexpr ('+' ^ mexpr)* EOF! ;
mexpr : atom ('*' ^ atom)* ;
atom : INT ;

```



Choosing AST Structure

Sequences of Things

Comma-separated lists are common

```

int gcd(int a, int b, int c)
args : "(" ( arg ("," arg)* )? ")" ;

```

A concrete parse tree:

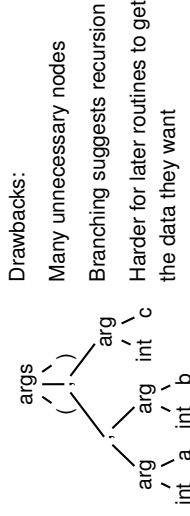

Sequences of Things

Better to choose a simpler structure for the tree.

Punctuation irrelevant; build a simple list.

```

int gcd(int a, int b, int c)
args : "("! ( arg (","! arg)* )? ")"!
      { #args = #([ARGS], args); } ;

```

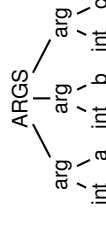

What's going on here?

```
args : "(! ( arg ( " ! arg ) * ) ? " ) !"  
{ #args = #([ARGS], args); } ;
```

Rule generates a sequence of arg nodes.

Node generation suppressed for punctuation (parens, commas).

Action uses ANTLR's terse syntax for building trees.

```
{ #args = #([ARGS], args); } ;
```

"set the args tree to a new tree whose root is a node of type ARGS and whose child is the old args tree"

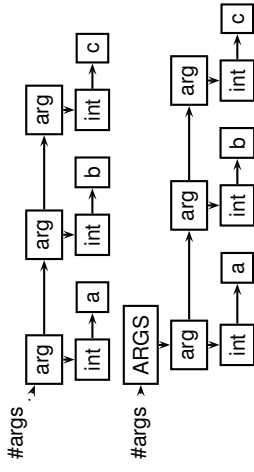

What's going on here?

```
(int a, int b, int c)  
args : "(! ( arg ( " ! arg ) * ) ? " ) !"  
{ #args = #([ARGS], args); } ;
```

Removing Unnecessary Punctuation

Punctuation makes the syntax readable, unambiguous. Information represented by structure of the AST

Things typically omitted from an AST

- Parentheses
- Grouping and precedence/associativity overrides
- Separators (commas, semicolons)
- Mark divisions between phrases
- Extra keywords while-do, if-then-else (one is enough)

Additional Grouping

The Tiger language from Appel's book allows mutually recursive definitions only in uninterrupted sequences:

```
let  
  function f1() = ( f2() ) /* OK */  
  function f2() = ( ... )  
in ... end  
  
let  
  function f1() = ( f2() ) /* Error */  
  var foo := 42 /* splits group */  
  function f2() = ( ... )  
in ... end
```

Grouping

Convenient to group sequences of definitions in the AST. Simplifies later static semantic checks.

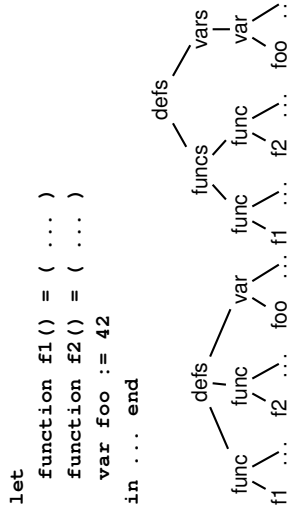

Grouping

Hint: Use ANTLR's **greedy** option to disambiguate this.

The greedy flag decides whether repeating a rule takes precedence when an outer rule could also work.

```
string : (dots)* ;  
dots : ( "." )+ ;
```

When faced with a period, the second rule can repeat itself or exit.

How Many Types of Tokens?

Since each token is a type plus some text, there is some choice.

Generally, want each "different" construct to have a different token type.

Different types make sense when each needs different analysis.

Arithmetic operators usually not that different.

For the assignment, you need to build a node of type "BINOP" for every binary operator. The text indicates the actual operator.

Grouping

Identifying and building sequences of definitions a little tricky in ANTLR.

Obvious rules

```
defs : ( funcs | vars | types ) * ;  
funcs : ( func )+ ;  
vars : ( var )+ ;  
types : ( type )+ ;
```

are ambiguous: Maximum-length sequences or minimum-length sequences?

Walking ASTs

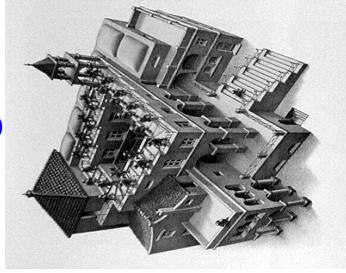

M. C. Escher, *Ascending and Descending*, 1960

Walking ASTs with ANTLR

```
class CalcWalker extends TreeParser
  expr returns [int r]
  { int a,b; r=0; }
  : #("+" a=expr b=expr) { r = a + b; }
  | #("*" a=expr b=expr) { r = a * b; }
  | i:INT { r = parseInt(i.getText()); }
  ;
```

This walker only has one rule: grammar had three.
Fine: only structure of tree matters.

Comments on walking ASTs

Optional clauses can cause trouble.
Place them at the end.

```
stmt
: #("if" expr stmt (stmt)?) // OK
| #("do" (stmt)? expr) // Bad
;
```

First rule works: can easily decide if there is another child.
Second rule does not: not enough lookahead.

Walking ASTs with ANTLR

ANTLR can build "tree parsers" as easily as token parsers.
Much simpler: tree structure is already resolved.
Simple recursive recursive walk on the tree.
Matches are sufficient, not exact.
(Cheaper to implement.)

```
# ( A B ) also matches the larger tree
# ( A # ( B C ) D )
```

Walking ASTs with ANTLR

```
: #("+" a=expr b=expr) { r = a + b; }
| #("*" a=expr b=expr) { r = a * b; }
| i:INT { r = parseInt(i.getText()); }
;
```

The highlighted line says
Match a tree # (. . .)

With the token "+" at the root
With two children matched by expr
(Store their results in a and b)

When this is matched, assign a + b to the result r.

Comments on walking ASTs

Lists of undefined length can also cause trouble

```
funcdef
: #("func" ID (arg) * stmt)
;
```

Does not work because the tree walker does not look ahead.

Solution: use a subtree

```
funcdef
: #("func" # ("args" (arg) *) stmt)
;
```

The placeholder resolves the problem.

Walking ASTs with ANTLR

```
class CalcParser extends Parser
  expr : mexpr ("+"^ mexpr)* ;
  mexpr : atom ("*"^ atom)* ;
  atom : INT | "(" expr ")" ;

class CalcWalker extends TreeParser
  expr returns [int r]
  { int a,b; r=0; }
  : #("+" a=expr b=expr) { r = a + b; }
  | #("*" a=expr b=expr) { r = a * b; }
  | i:INT { r = parseInt(i.getText()); }
  ;
```

Comments on walking ASTs

Tree grammars may seem to be ambiguous.

Does not matter: tree structure already known

Unlike proper parsers, tree parsers have only one token of lookahead.

Must be possible to make a decision locally.
Has impact on choice of AST structure.

Rewriting Trees with ANTLR

Rewriting Trees

Much of compiling is refining and simplifying:

- Discarding unnecessary information

- Reducing high-level things to low-level ones

How to implement this depends on the representation.

Trees are fairly natural: replace one or more children.

ANTLR tree walkers can do semi-automatically.

Rewriting Trees with ANTLR

In the parser, `buildAST=true` adds rules that automatically builds an AST during parsing.

In a tree walker, `buildAST=true` adds code that automatically makes a copy of the input tree.

This is actually useful because you can selectively disable it and generate your own trees.

Rewriting Trees with ANTLR

An example: Replace `x+0` with `x`.

First, make a copying `TreeParser`:

```
class FoldZeros extends TreeParser;
options {
    buildAST = true;
}

expr
: # "+" expr expr
| # "*" expr expr
| INT
;

```

Rewriting Trees with ANTLR

Next, disable automatic rewriting for the `+` operator and add a manual copy.

Adding `!` before a subrule disables AST generation for that subrule.

Tree generation is like that in parsers.

```
expr
: ! # (PLUS left: expr right: expr)
  { #expr = # (PLUS, left, right); }
| # (STAR expr expr)
| i: INT
;

```

Rewriting Trees with ANTLR

Finally, check for the `x+0` case.

```
expr
: ! # (PLUS left: expr right: expr)
{
    if (#right.getType() == INT &&
        Integer.parseInt (#right.getText ()) == 0)
        #expr = #left;
    else
        #expr = # (PLUS, left, right);
}
| # (STAR expr expr)
| i: INT
;

```

Complete Example

class `CalcTreeWalker` extends `TreeParser`;

```
options { buildAST = true; }

expr
: ! # (PLUS left: expr right: expr) {
    if ( #right.getType () == INT &&
        Integer.parseInt (#right.getText ()) == 0 )
        #expr = #left;
    else #expr = # (PLUS, left, right);
}
| # (STAR expr expr)
| i: INT
;

```

Examples of Tree Rewriting

This was incomplete: should do `0+x` case, too.

General constant folding: replace constant arithmetic expressions with their results.

Must do this carefully: watch for overflow, imprecision.

Tricky to do correctly for integers, virtually impossible for floating-point.

Cross-compilation problem: how do you know the floating-point unit on your target machine behaves exactly like the one where you're compiling?

Examples of Tree Rewriting

Change logical operators `&&` and `||` to if-then statements.

```
if (a && b && c || d && e) { ... }

if (a) {
    if (b)
        if (c)
            goto Body;
    } else if (d)
        if (e) {
            Body: ...
        }
}

```

Examples of Tree Rewriting

Dismantle loops into `gotos`.

```
while (a < 3) {
    printf("a is %d", a);
    a++;
}

Becomes

goto Continue;
Again:
    printf("a is %d", a);
    a++;
Continue:
    if (a < 3) goto Again;

```